

Une brève histoire des machines à calculer mécaniques

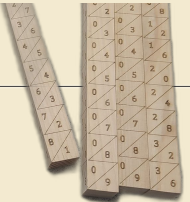

par François Delannoy

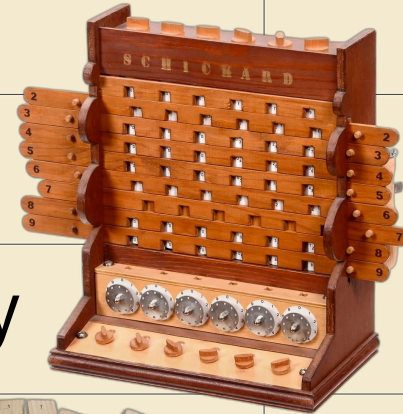
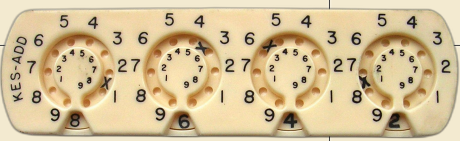
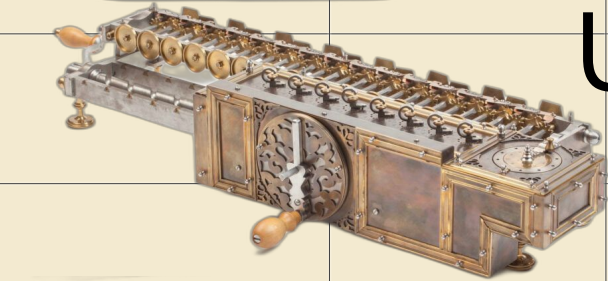
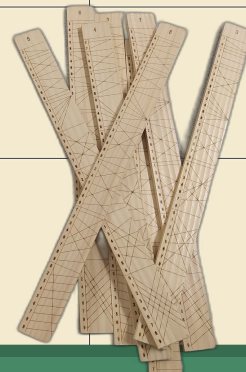
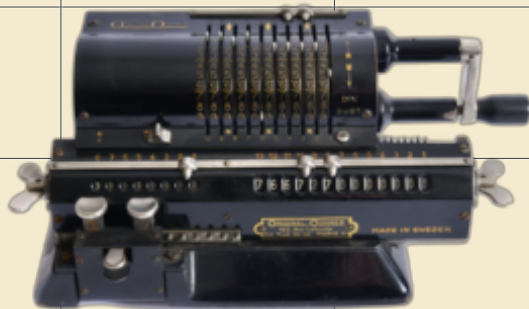
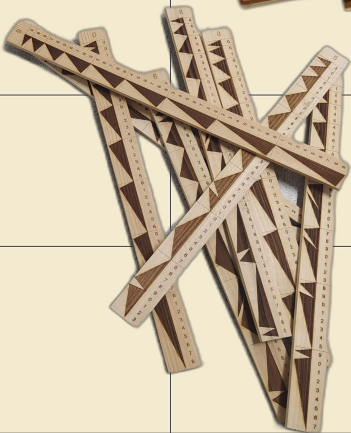
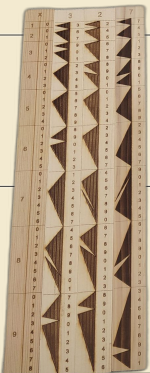

Systeme de
numération adapté ...

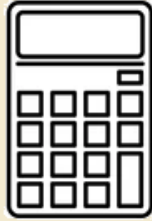

Techniques en
mécanique de précision
suffisamment adaptées

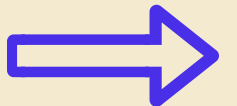

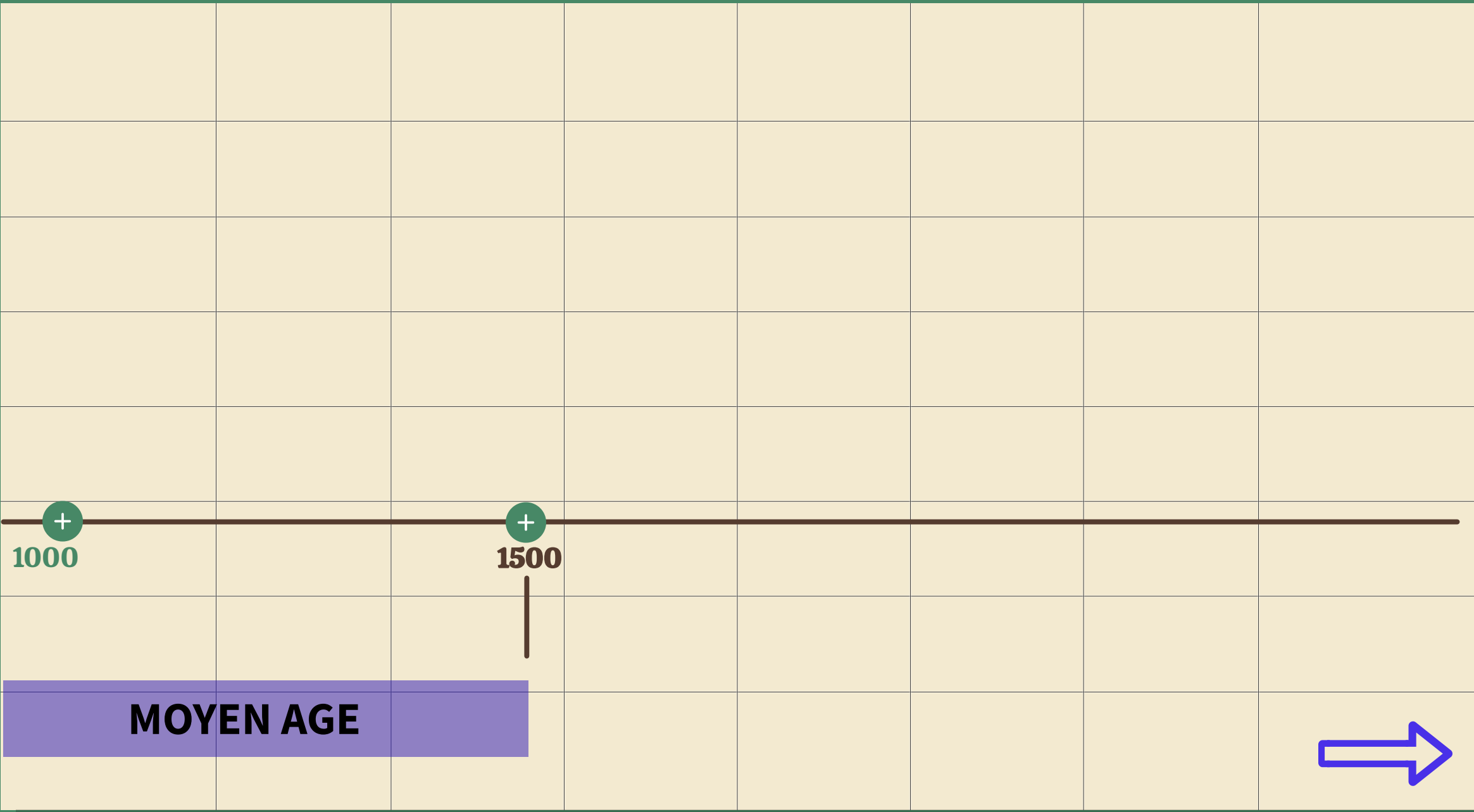

+

1000

+

1500

MOYEN AGE

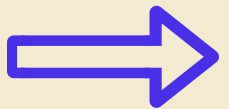



+

1000

Gerber D'Aurillac
Pape Sylvestre II

+

1500

MOYEN AGE



C D S			C D S		
			9		8
				9	5
		1			3

\bar{c}	\bar{x}	\bar{i}	c	x	i
				1	3
				8	7
		5		1	6
5			b	6	
			b	3	6
1				4	b

13
87
4 019
400 520
539
100 065



Systeme de
numération adapté ...



Techniques en
mécanique de précision
suffisamment adaptées





+

1000

Gerber D'Aurillac
Pape Sylvestre II

+

1500

MOYEN AGE



Systeme de
numeration adapte ...



... accepte et repandu



Techniques en
mecanique de precision
suffisamment adaptees

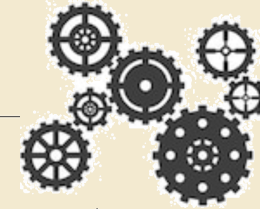

Systeme de
numeration adapte ...



... accepte et repandu



Philosophie



Techniques en
mecanique de precision
suffisamment adaptees

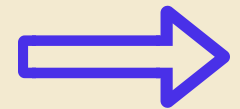

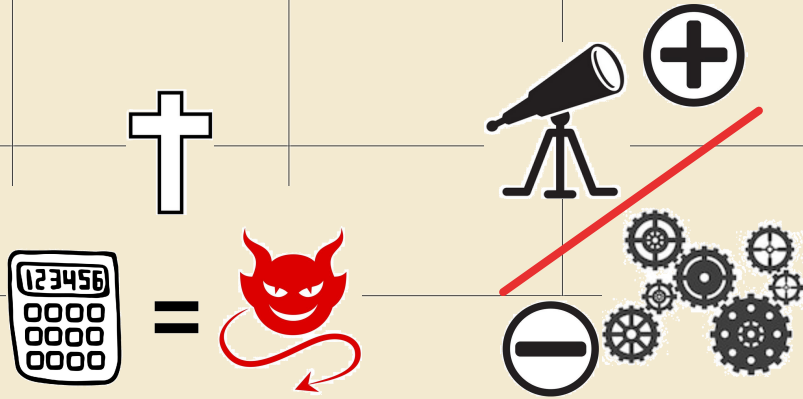

+
1000

Gerber D'Aurillac
Pape Sylvestre II

+
1500

+
1600

MOYEN AGE

RENAISSANCE

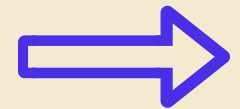

$$451 \times 35 = ?$$

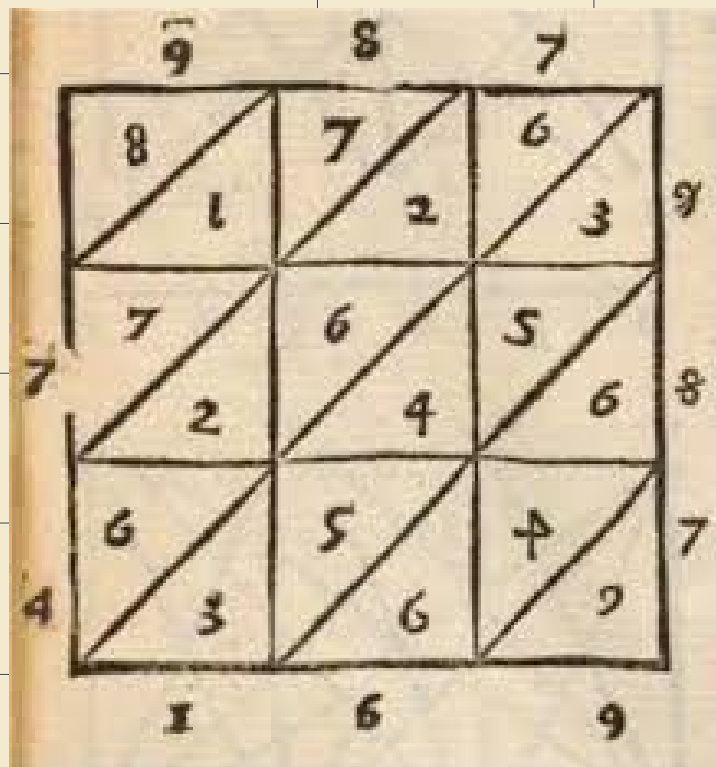

$$451 \times$$

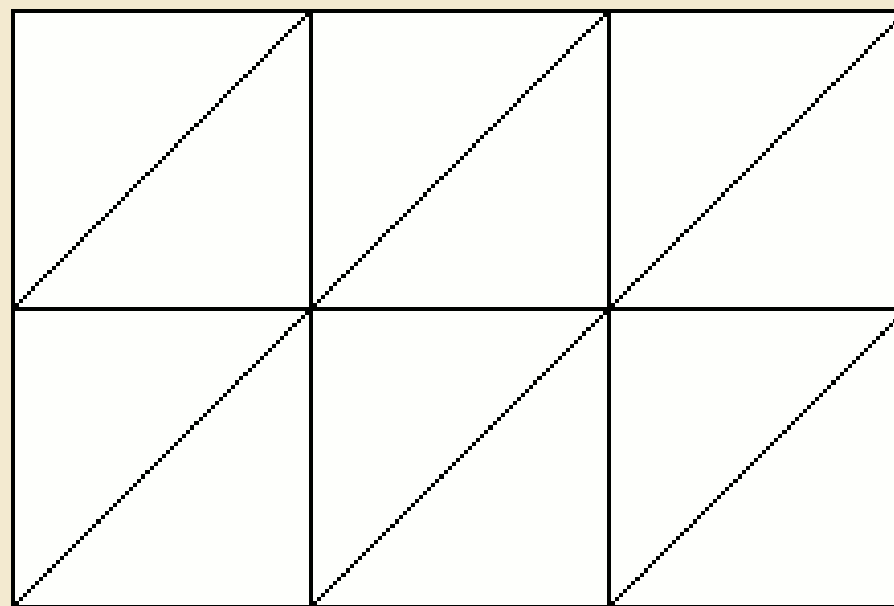

3

5



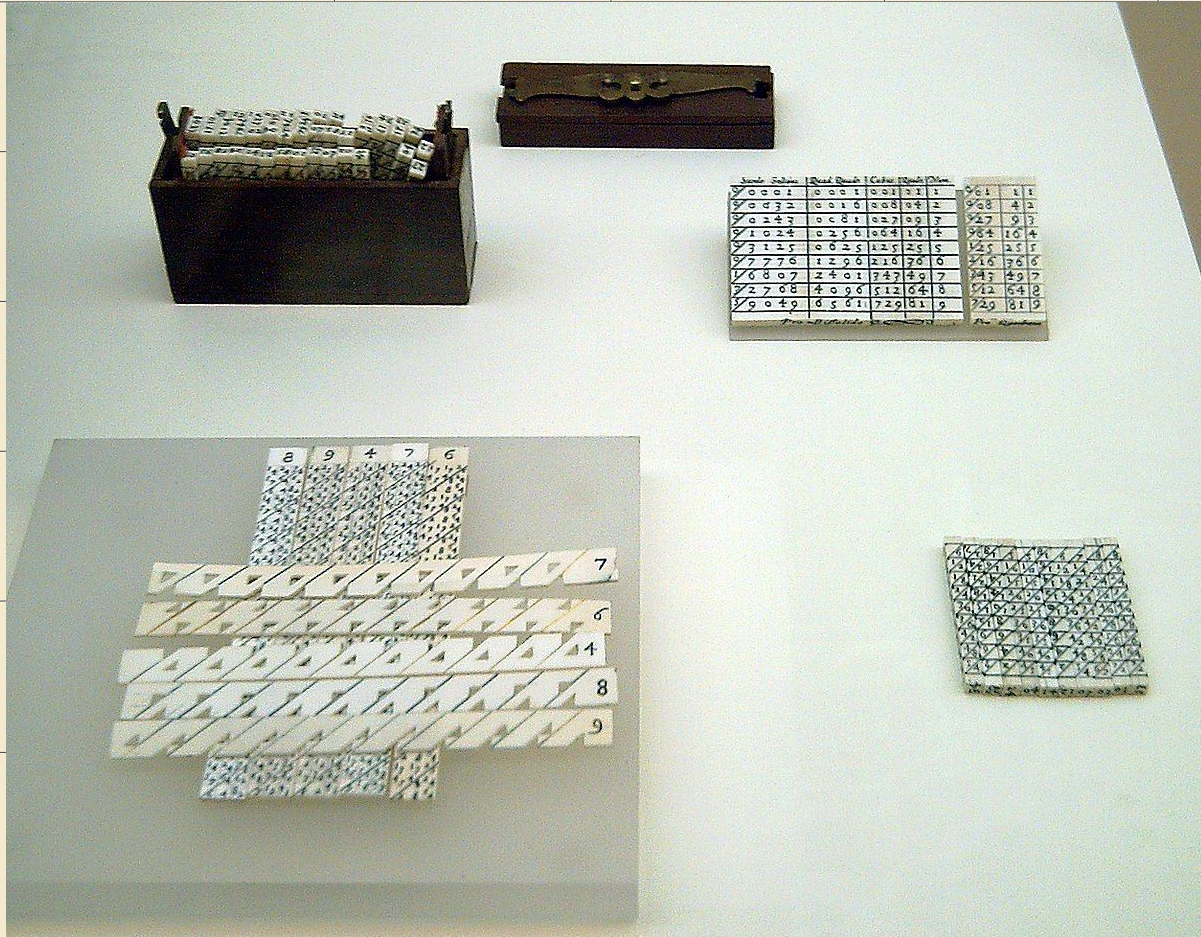
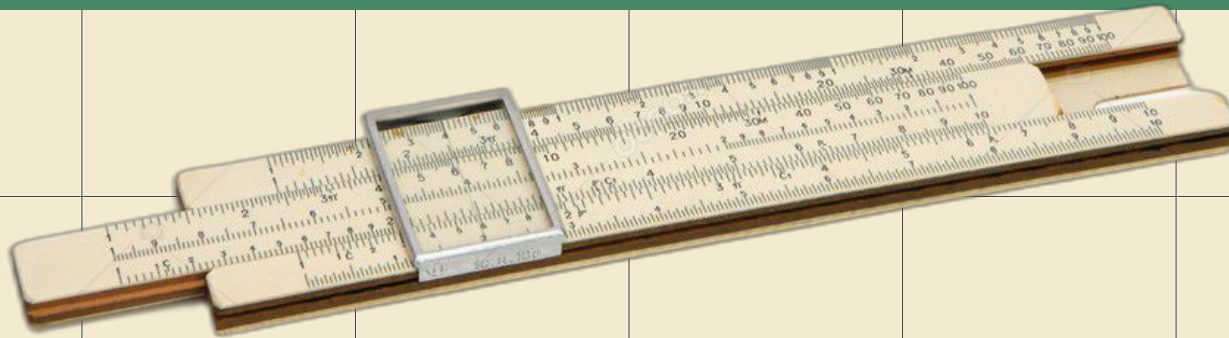

x	5	2	3
1	0 5	0 2	0 3
2	1 0	0 4	0 6
3	1 5	0 6	0 9
4	2 0	0 8	1 2
5	2 5	1 0	1 5
6	3 0	1 2	1 8
7	3 5	1 4	2 1
8	4 0	1 6	2 4
9	4 5	1 8	2 7

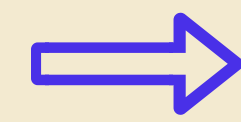
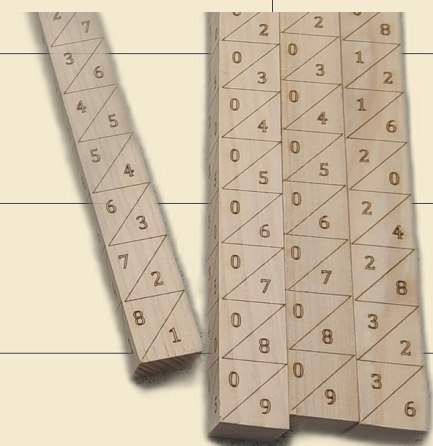

Systeme de
numeration adapte ...



Techniques en
mecanique de precision
suffisamment adaptees



... accepte et repandu

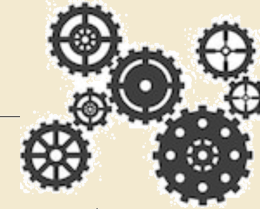

Philosophie



Une utilite ?
La comptabilite et le
commerce



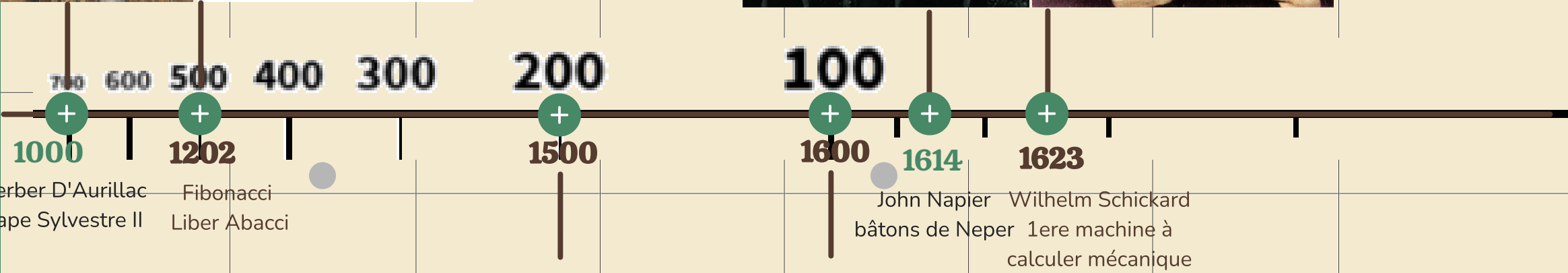
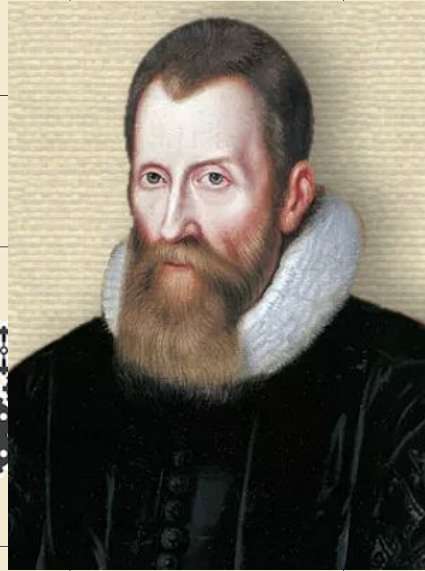
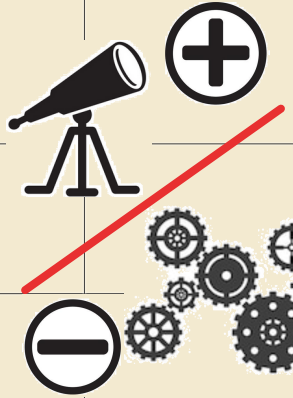

MOYEN AGE

RENAISSANCE

EPOQUE MODERNE



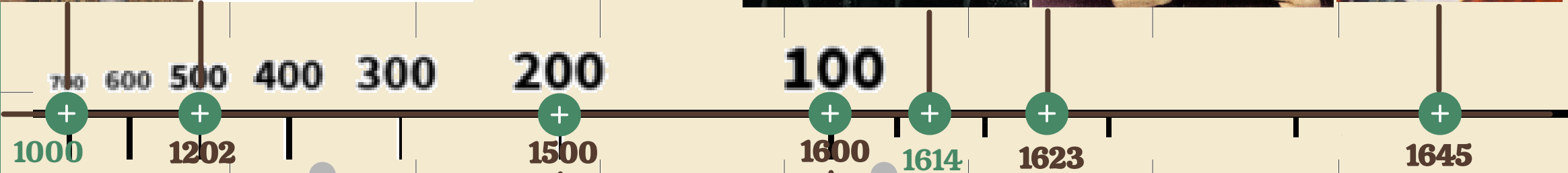
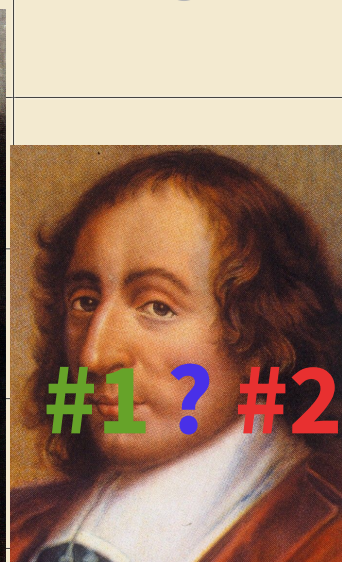
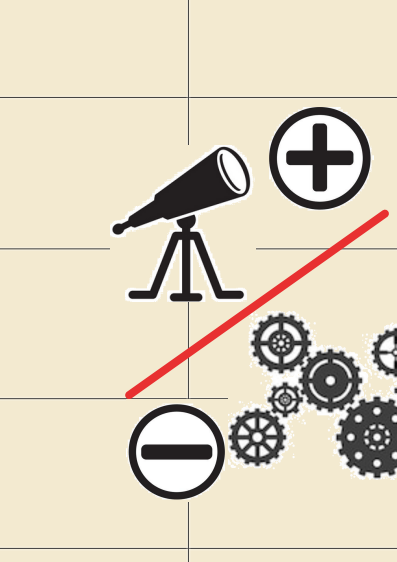

Gerber D'Aurillac
Pape Sylvestre II

Fibonacci
Liber Abacci

1500

1600
John Napier
bâtons de Neper

1623
Wilhelm Schickard
1ere machine à
calculer mécanique

1645
Blaise Pascal
1ere machine à
calculer mécanique

MOYEN AGE

RENAISSANCE

EPOQUE MODERNE

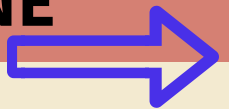

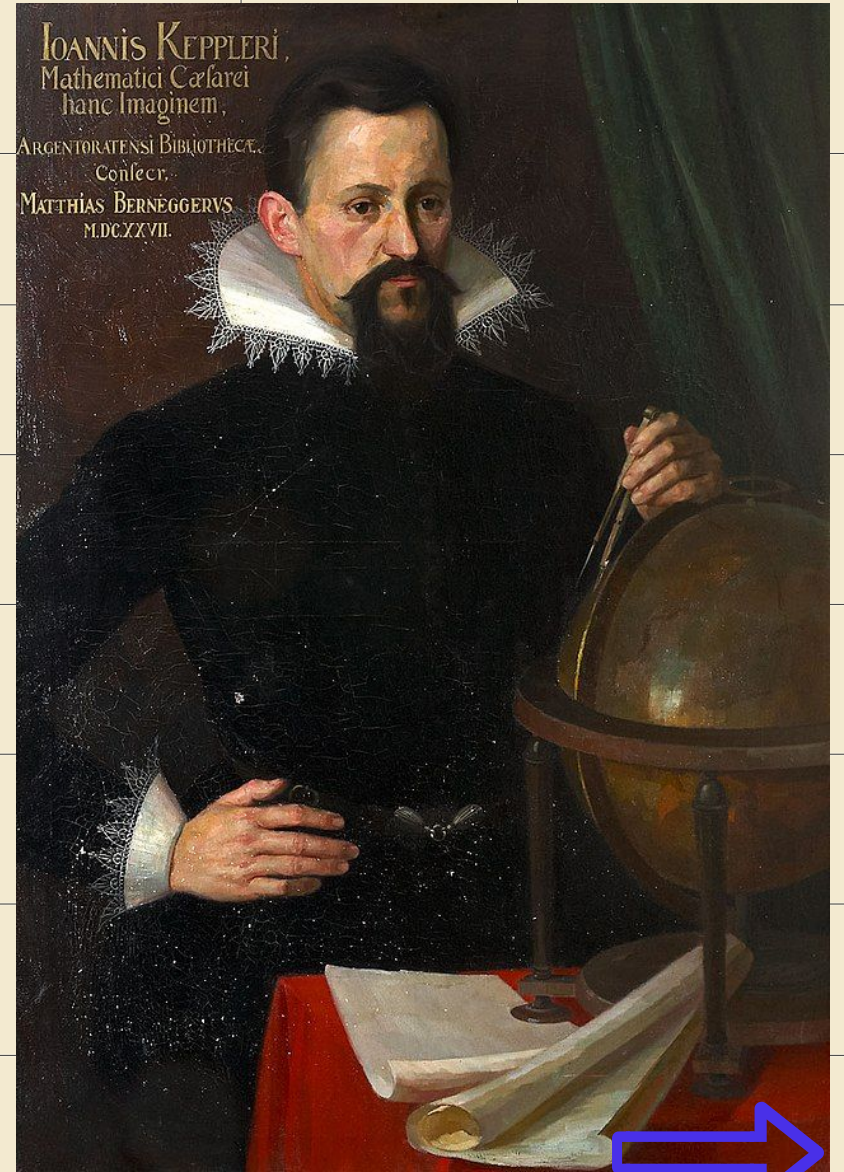

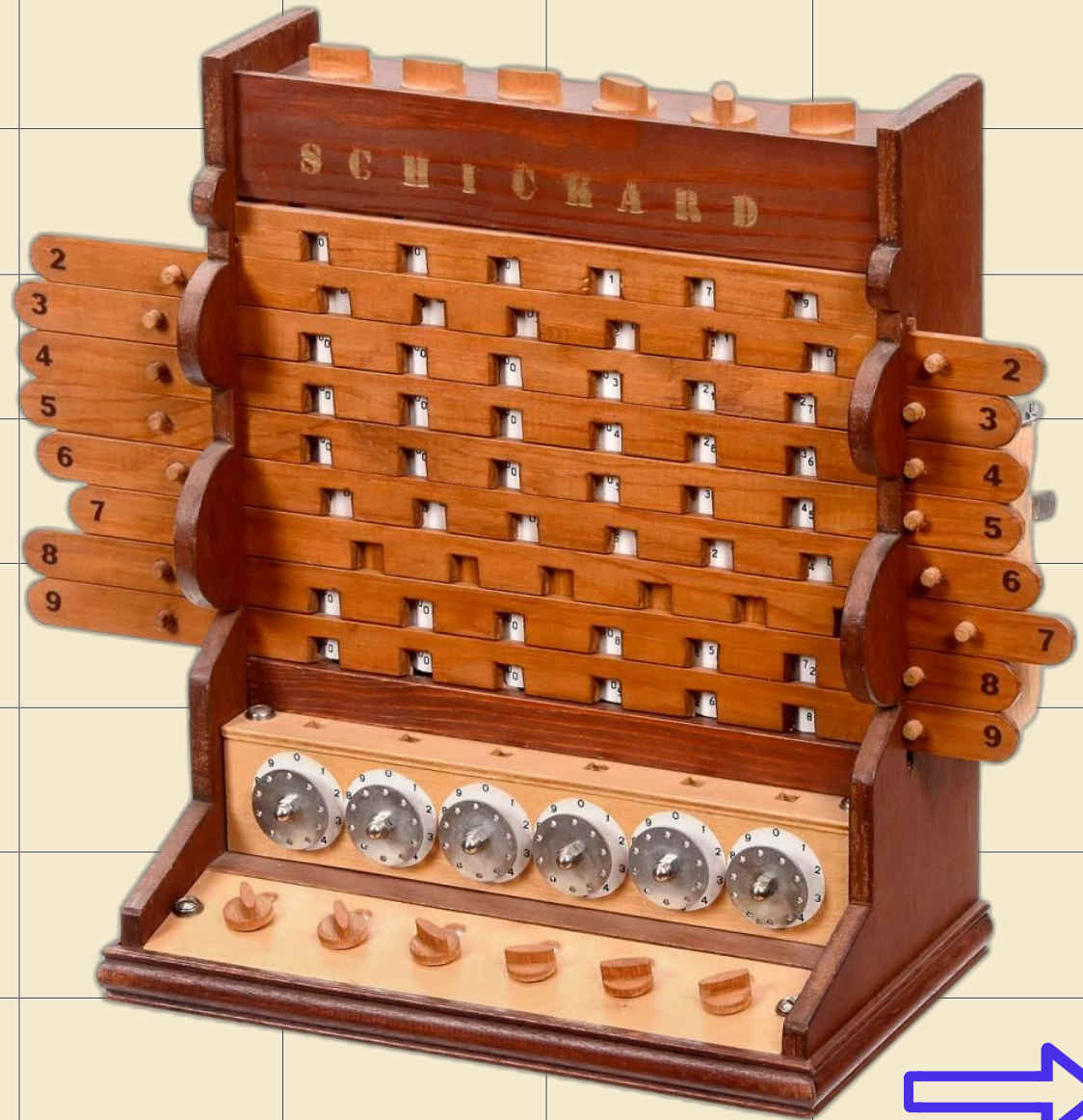
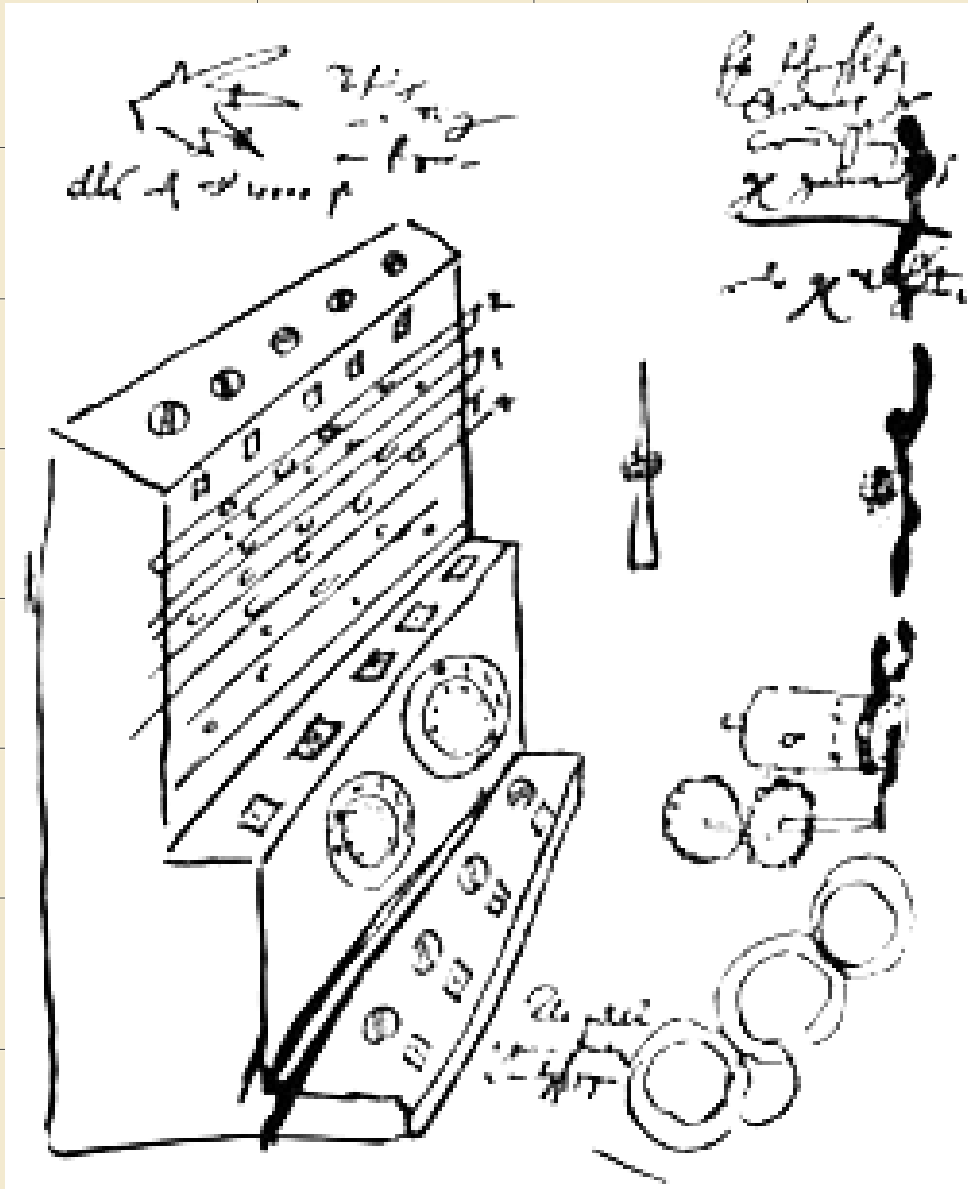

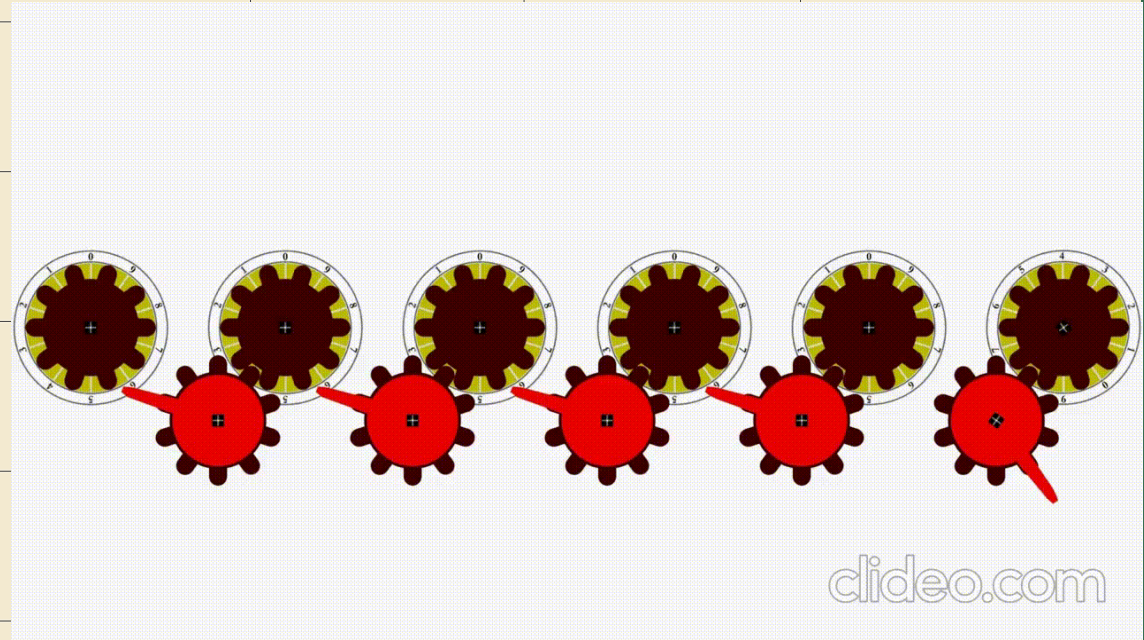
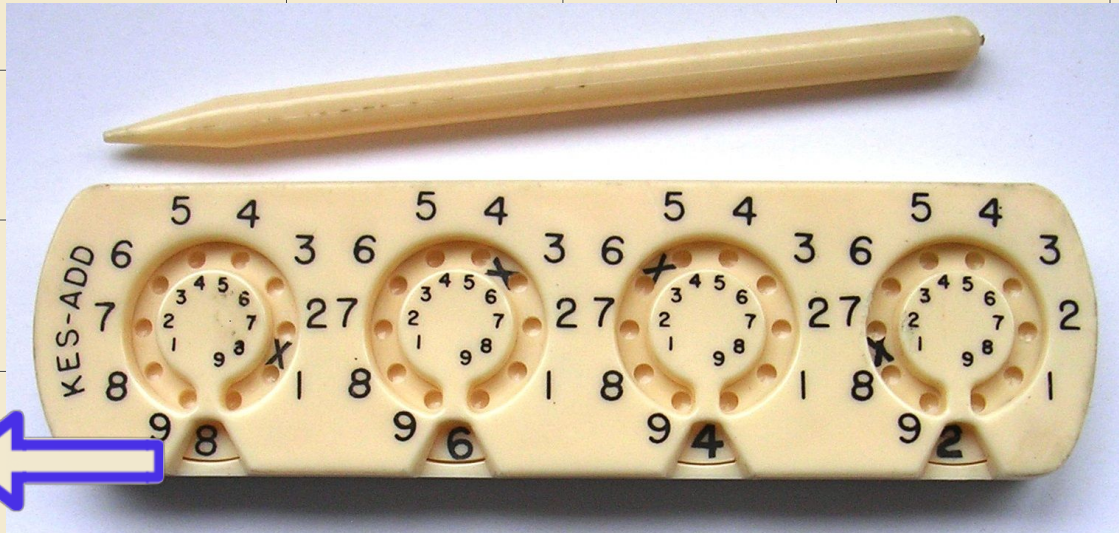

clideo.com

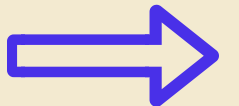

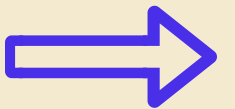

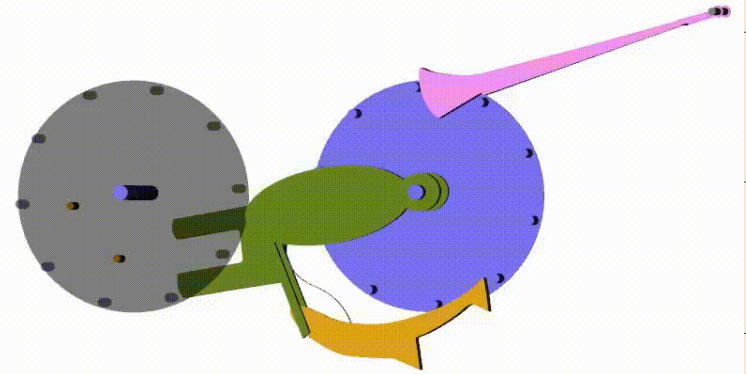
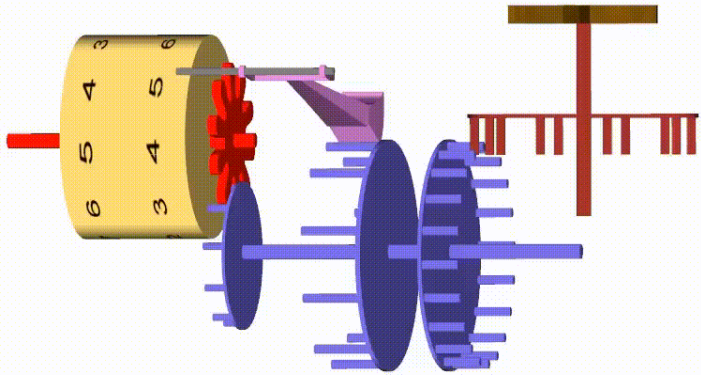
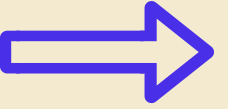

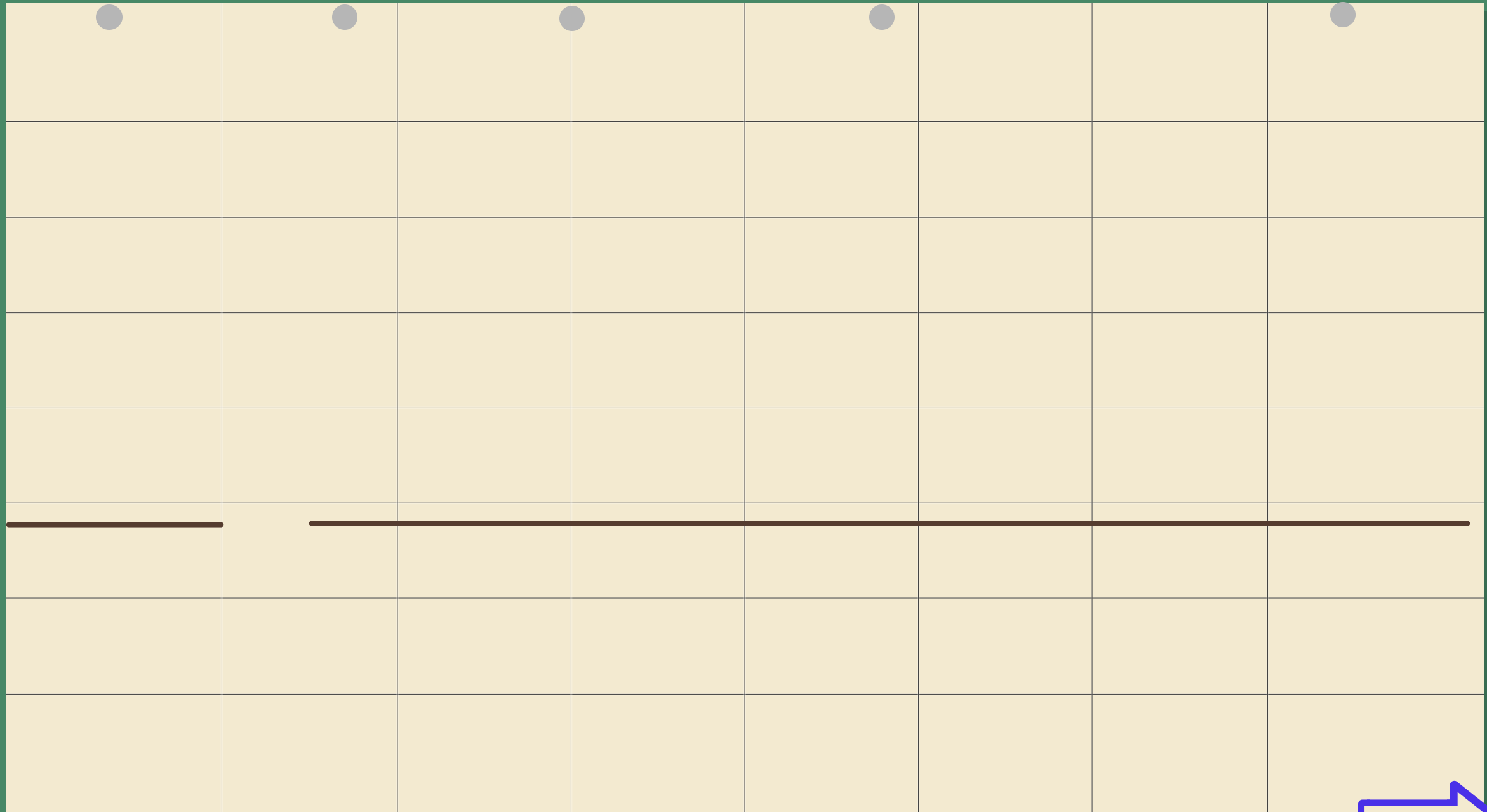



+

1671

Gottfried Wilhelm
Leibniz





+

1671

Gottfried Wilhelm
Leibniz



+

1820

Thomas de Colmar

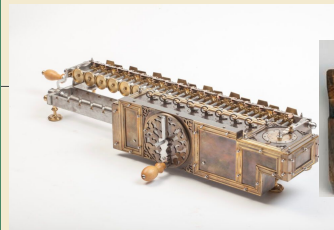



+

1671

Gottfried Wilhelm
Leibniz

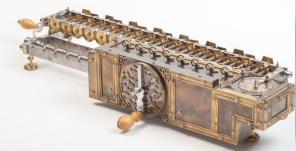

+

1820

Thomas de Colmar



+

1873

Willgdt Theophil
Odhner





Les additionneuses

+

1671

Gottfried Wilhelm
Leibniz

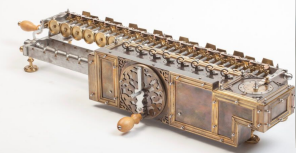

+

1820

Thomas de Colmar



+

1873

Willgdt Theophil
Odhner



+



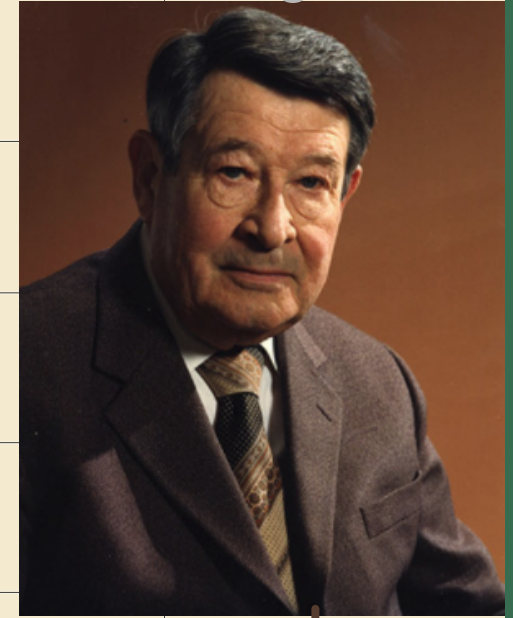

Les additionneuses

+

1671

Gottfried Wilhelm
Leibniz



+

1820

Thomas de Colmar



+

1873

Willgdth Theophil
Odhner



+

+

1947

Curt Herzstark
Curta



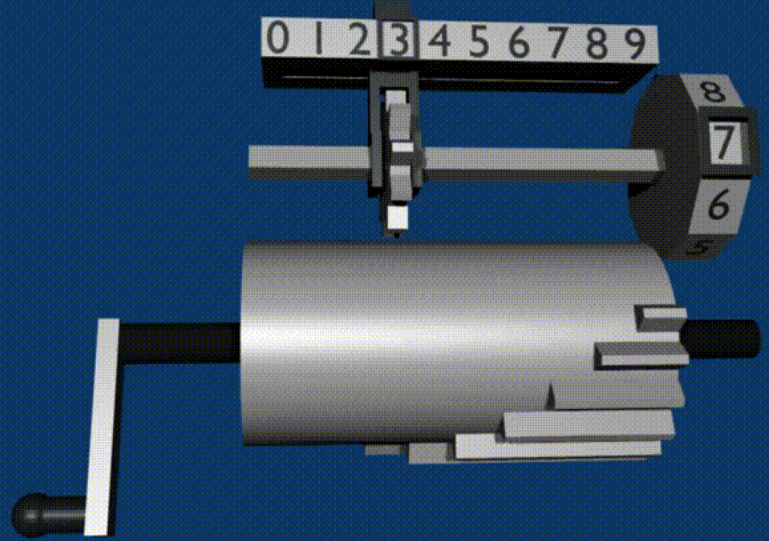
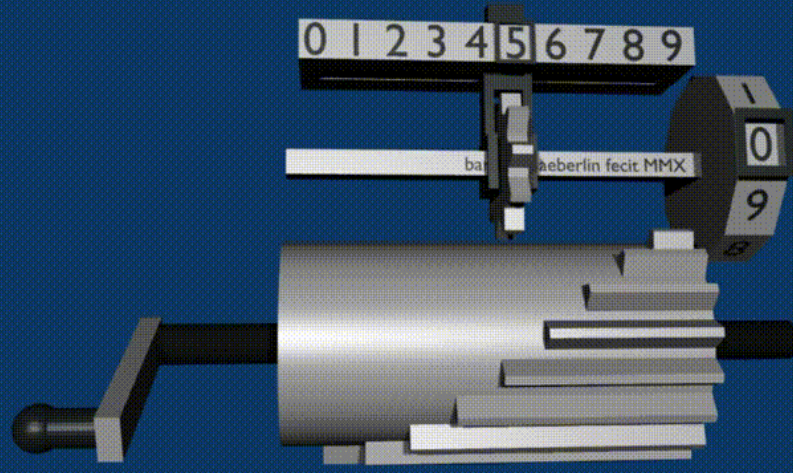
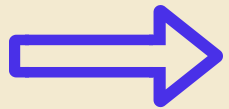
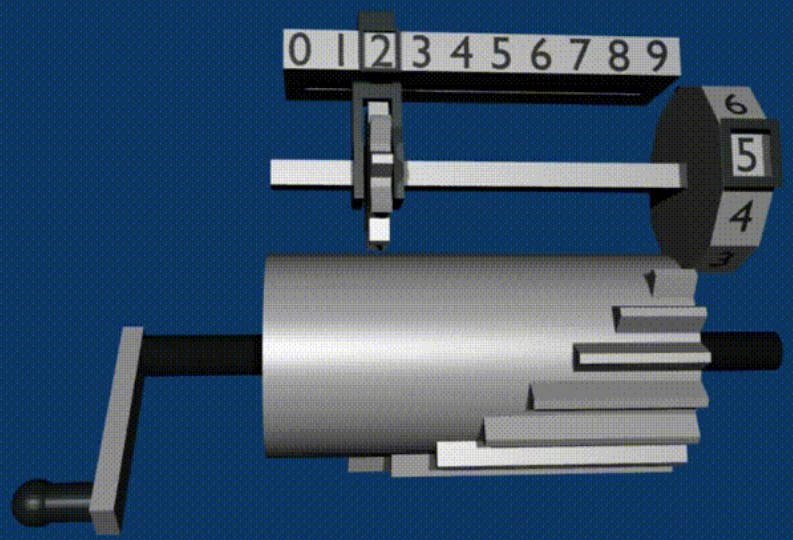
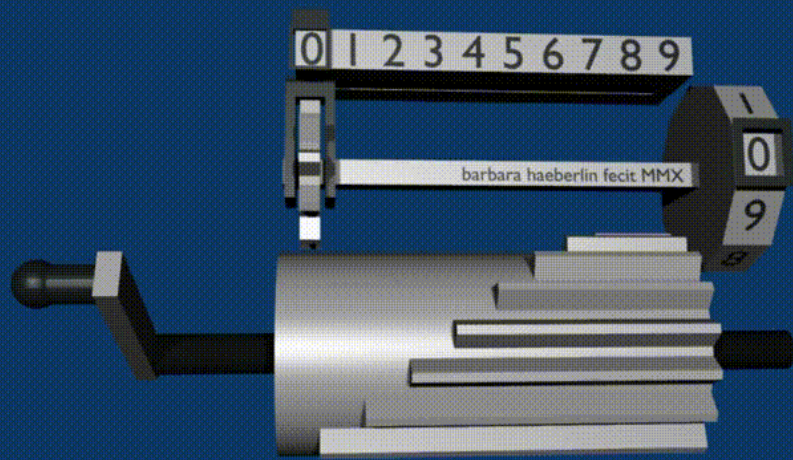

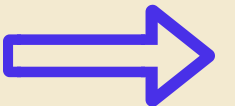
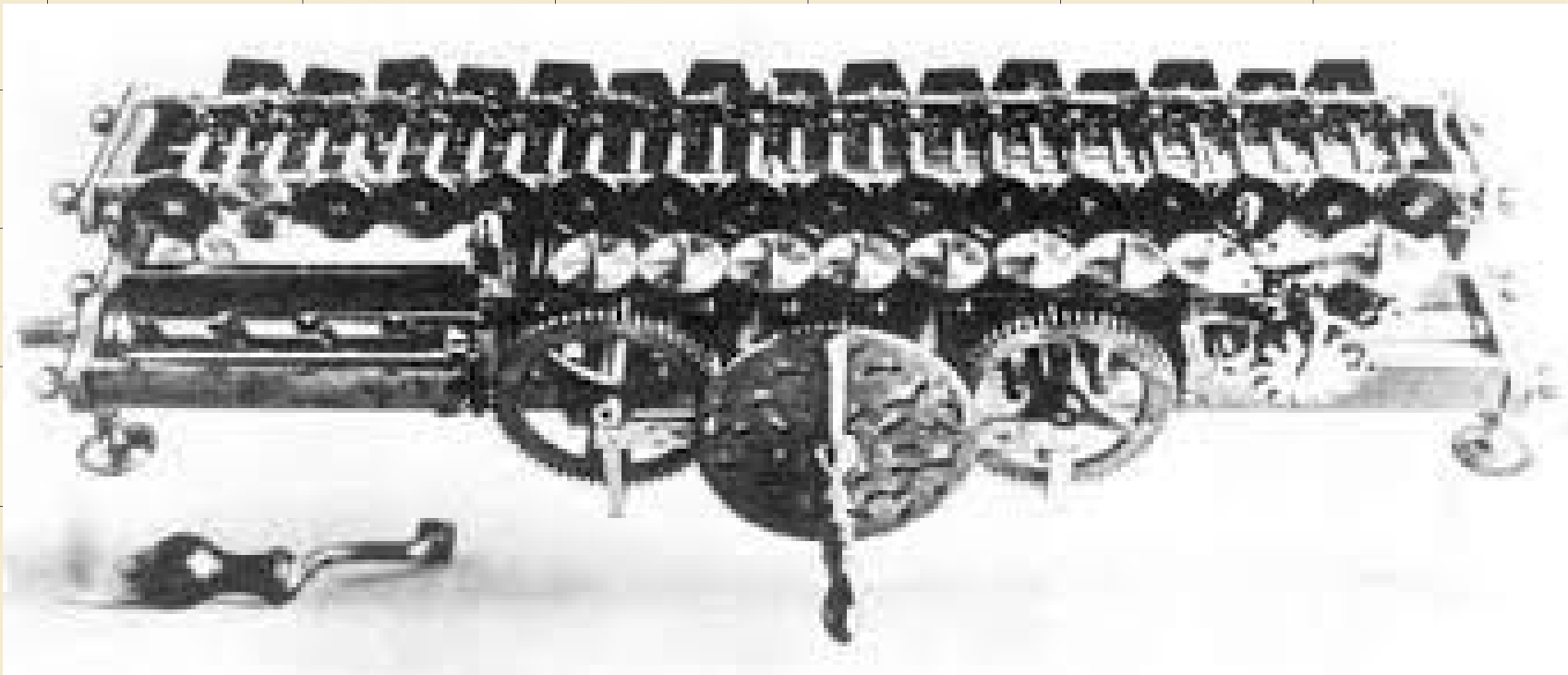
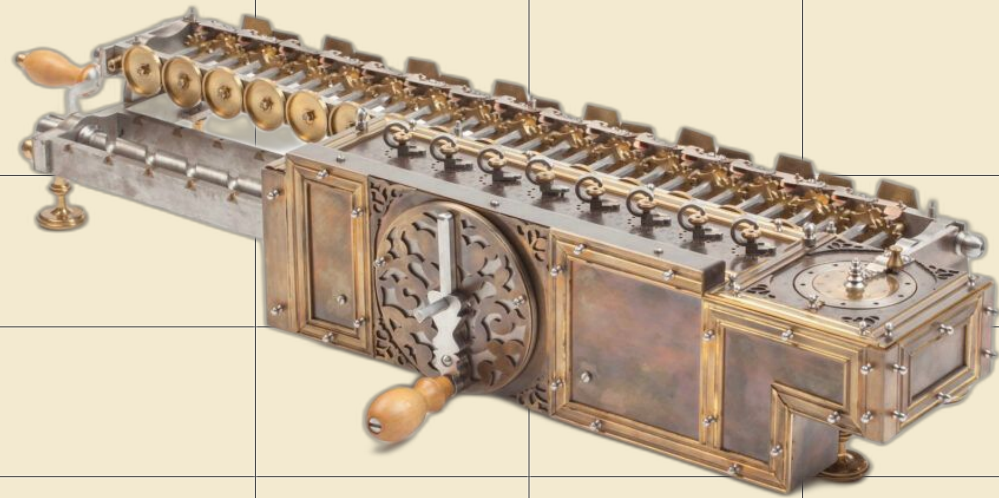

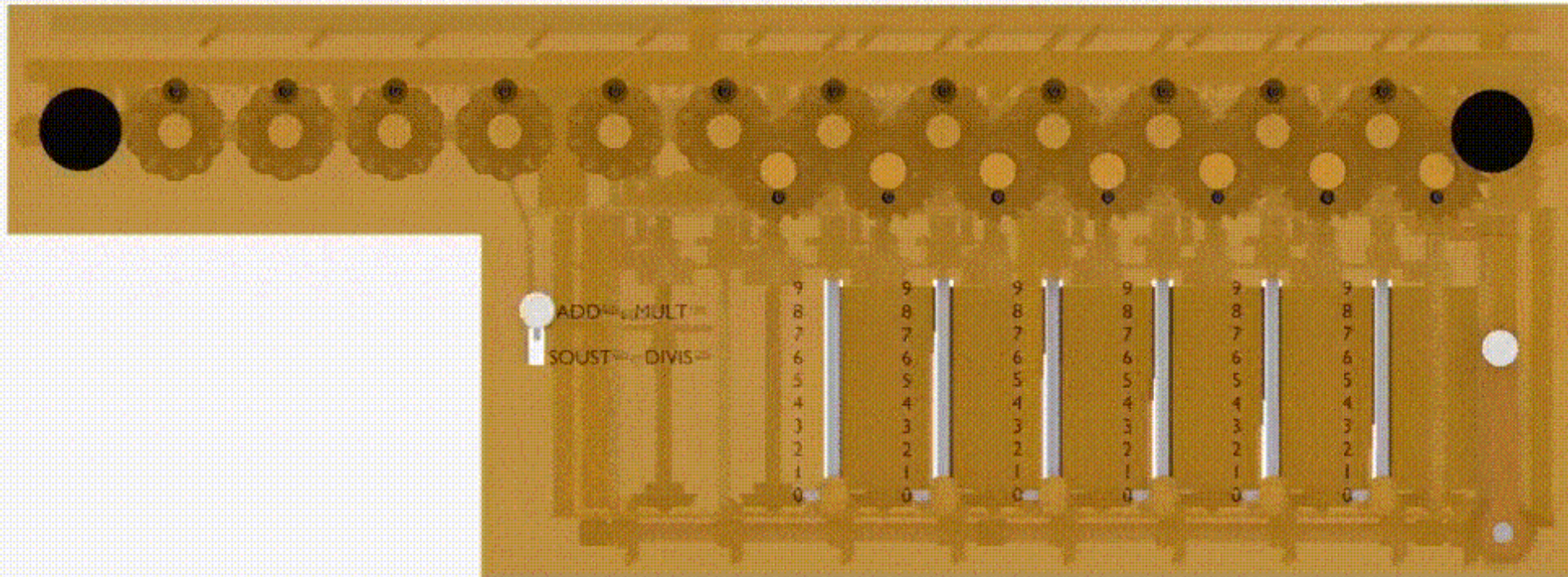

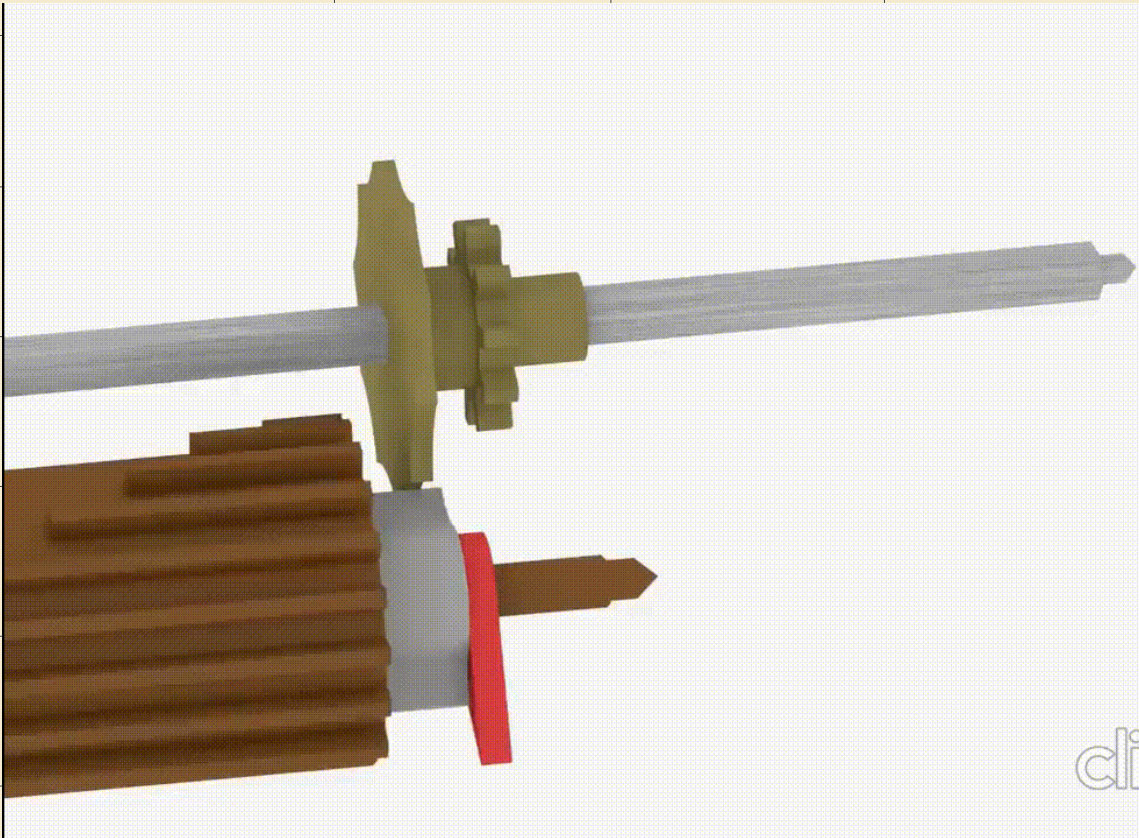

click

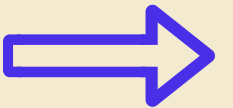
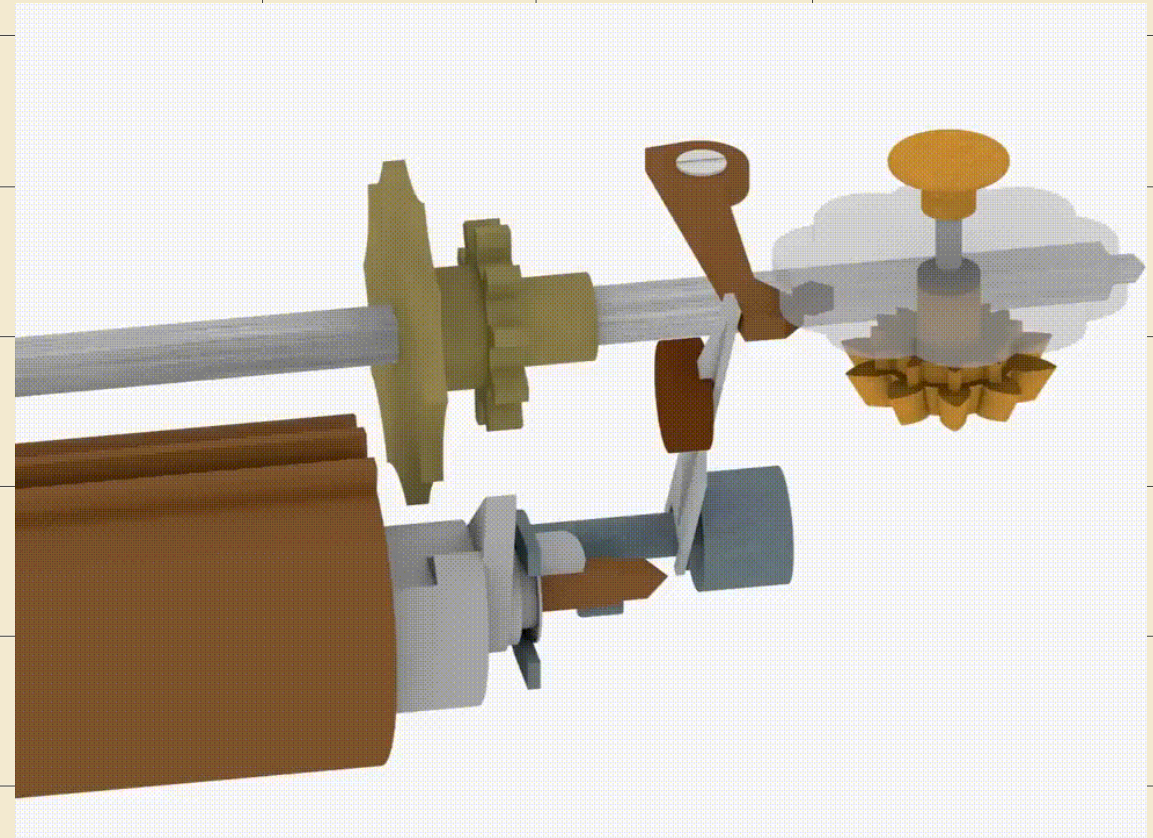

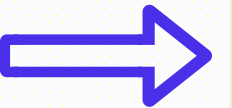
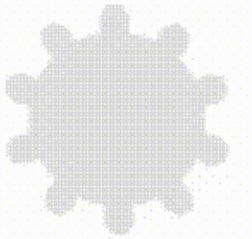
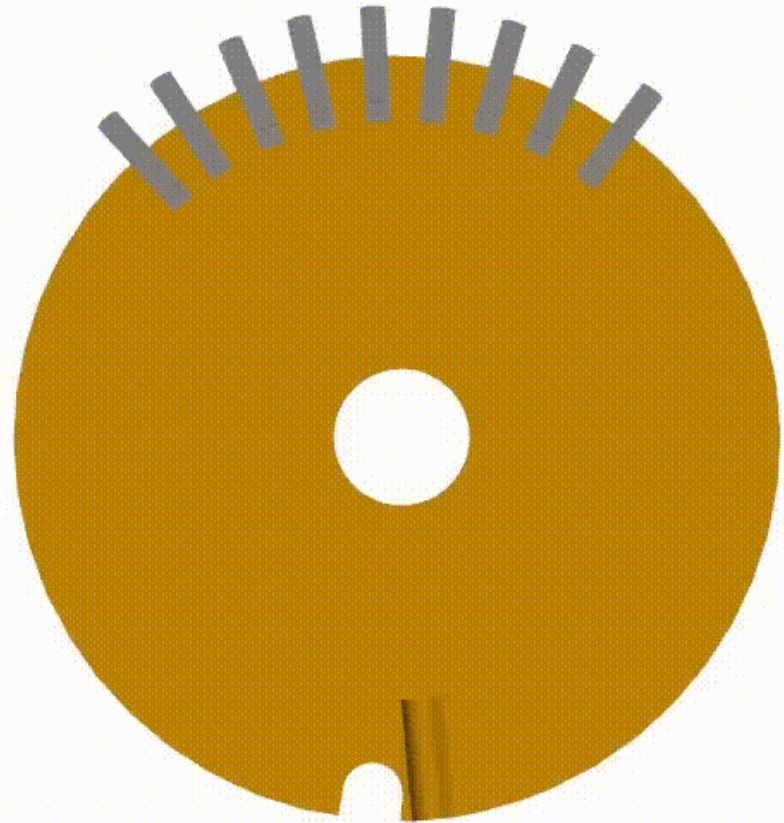
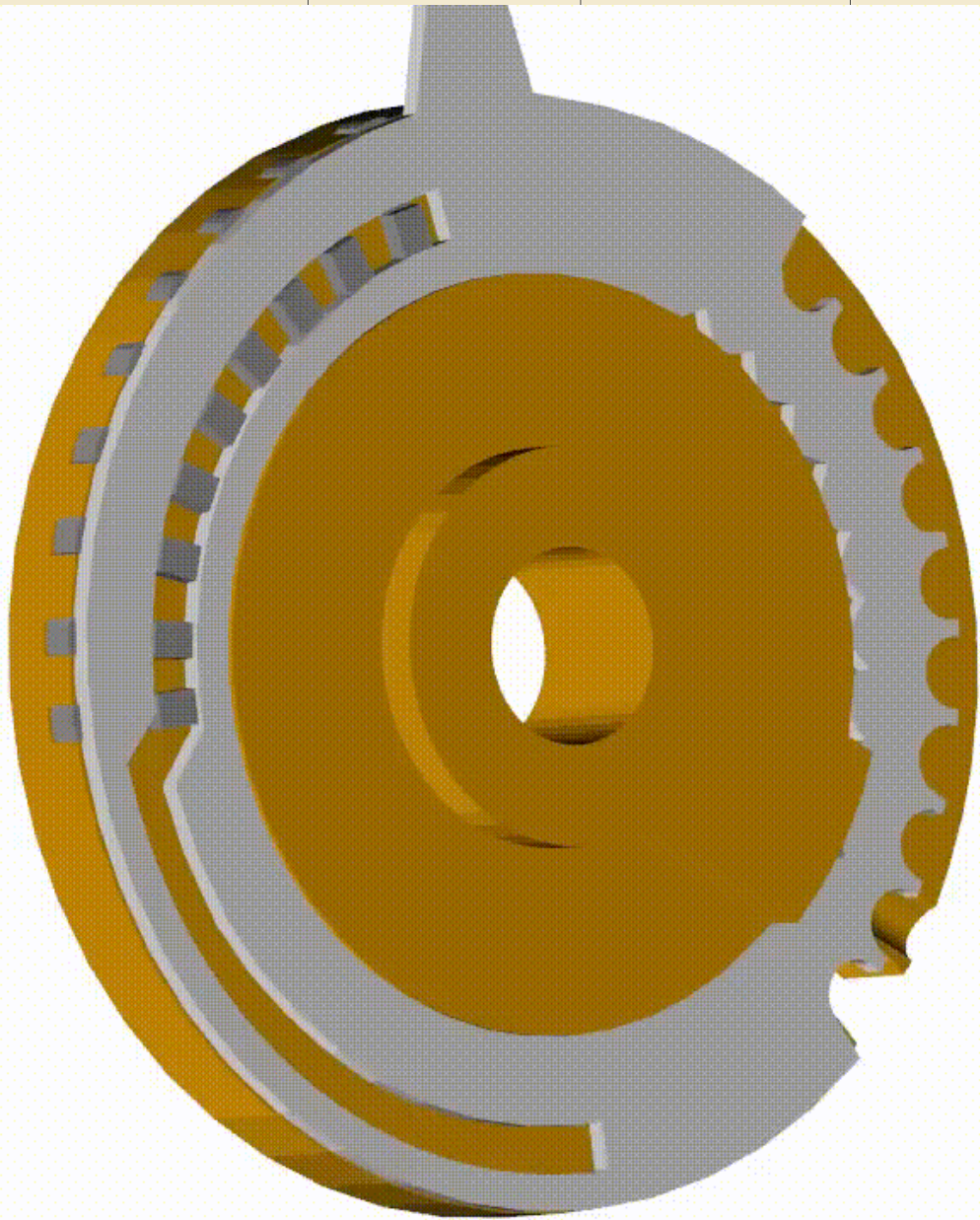

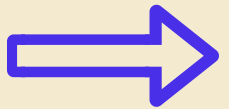
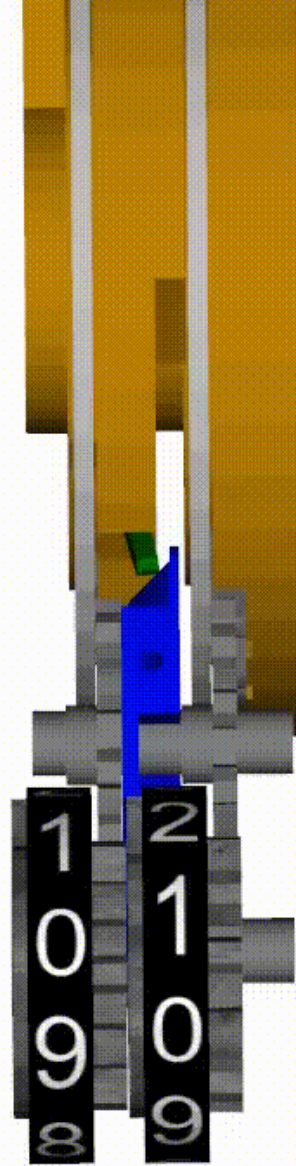
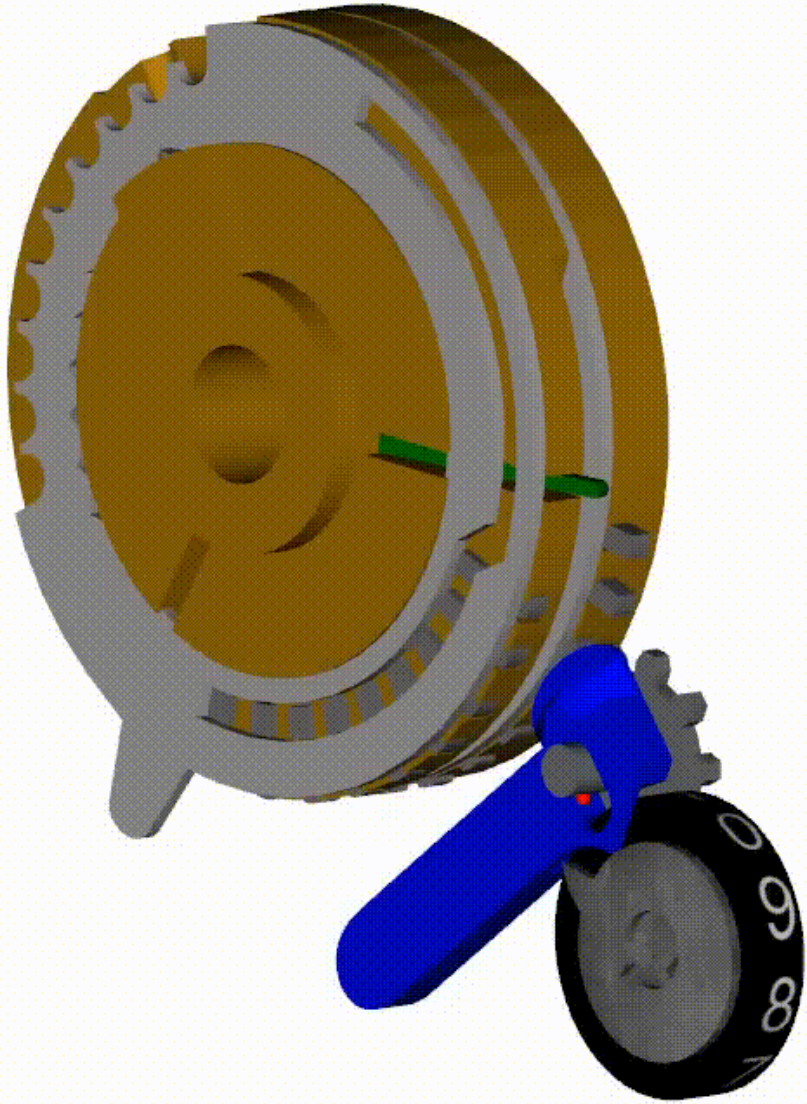



1770



1947

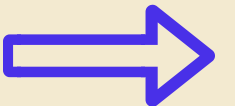

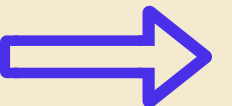
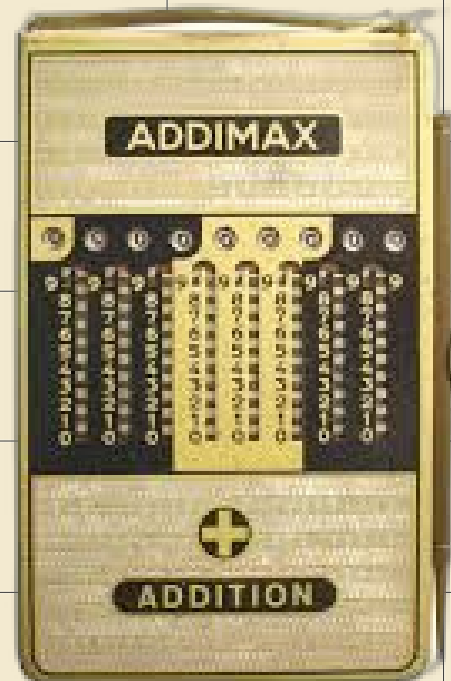
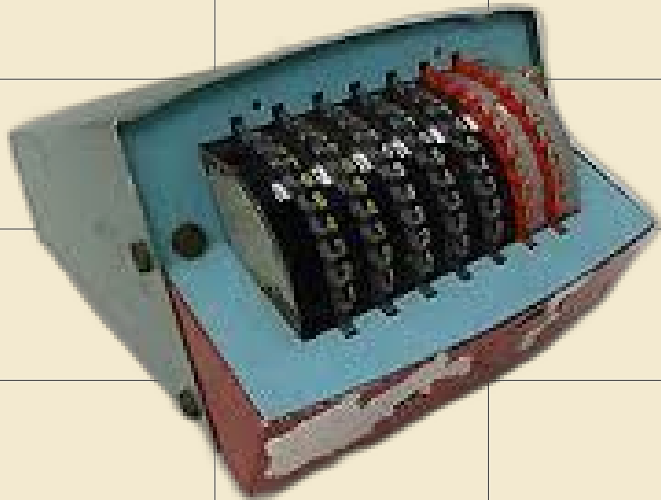
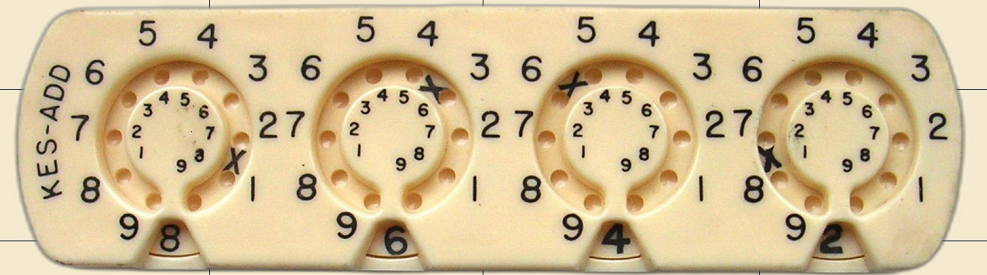

La caroline

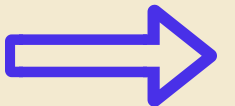
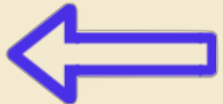
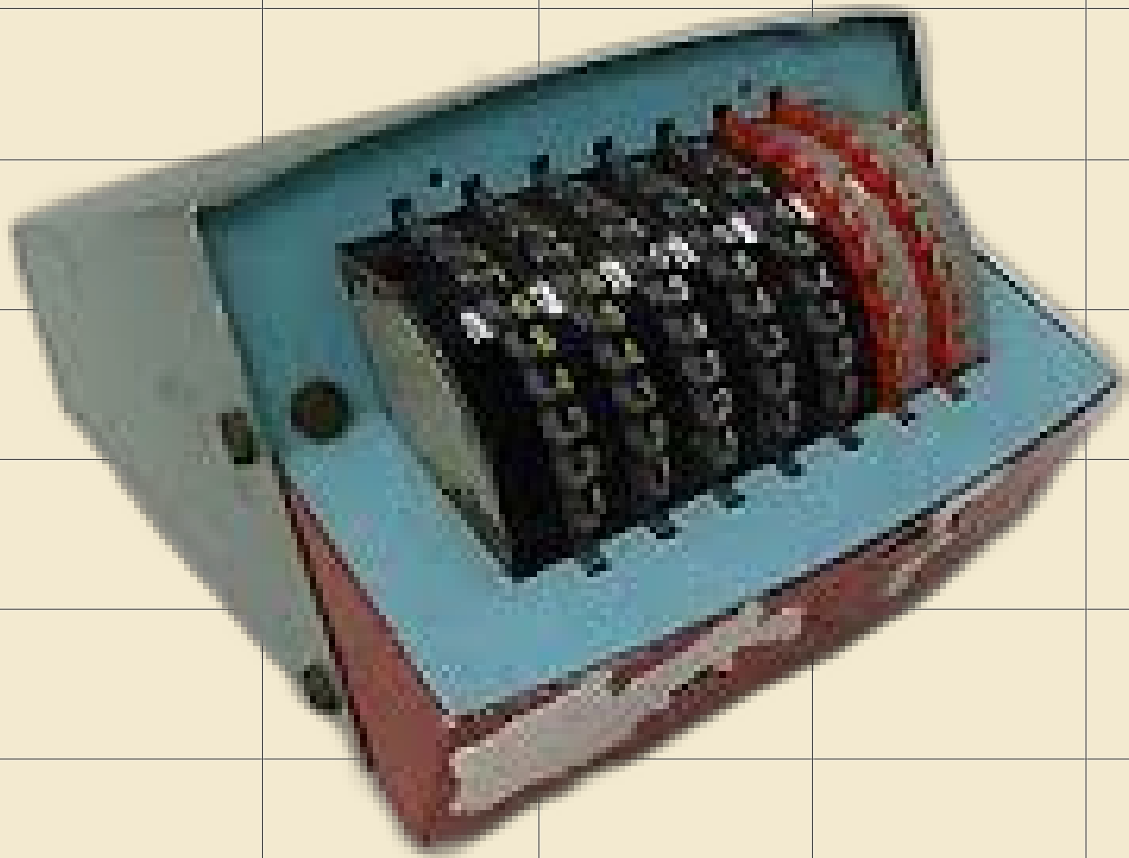

Bibliographie

- Le musée Henri Poincaré - Collection de machines à calculer
<https://patrimoine.ihp.fr/page/machines>
- Livre : Calculus - Luc de Brabandère - ed. Mardaga (livre)
- Livre : Histoire des instruments et machines à calculer - Jean Marguin -ed. Hermann (livre)
- Livre : Que sais-je ? Le calcul mécanique - R. Taton et J-P Flad - Presses universitaires de France
- Chaine Youtube : Mechanicalcomputing - Michael L. Hilton
- Chaine Youtube : Yves Serra
- Site web : aventureducalcul.fr - Yves Serra
- Site web : www.arithmometre.org - Valéry Monnier
- Site web : www.collections.hardy-jm.fr/ - Jean-Marie Hardy